



SOLVAY

asking more from chemistry®

Radel® | Udel® | Veradel® | Acudel®

**Radel® PPSU, Udel® PSU,
Veradel® PESU &
Acudel® modified PPSU**

Processing Guide

**SPECIALTY
POLYMERS**

Table of Contents

Introduction	5	Part Ejection	14
Sulfone Polymers	5	Draft	14
Udel® Polysulfone (PPSU)	5	Ejector pins and/or stripper plates	14
Veradel® Polyethersulfone (PESU)	5	Injection Molding Equipment	15
Radel® Polyphenylsulfone (PPSU)	5	Controls	15
Acudel® modified PPSU	5	Clamp	15
Resin Drying	6	Barrel Capacity	15
Rheology	8	Press Maintenance	15
Viscosity-Shear Rate	8	Screw Design	15
Resin Flow Characteristics	9	Screw Tips and Check Valves	15
Melt flow index	9	Nozzles	16
Spiral flow	9	Molding Process	16
Injection Molding	10	Polymer Injection or Mold Filling	16
Molds and Mold Design	10	Packing and Holding	17
Tool Steels	10	Cooling	17
Mold Dimensions	10	Machine Settings	17
Mold Polishing	10	Barrel Temperatures	17
Mold Plating and Surface Treatments	10	Mold Temperature	18
Tool Wear	10	Residence Time in the Barrel	18
Mold Temperature Control	10	Injection Rate	18
Mold Types	11	Back Pressure	18
Two-plate molds	11	Screw Speed	18
Three-plate molds	11	Shrinkage	18
Hot runner molds	11	Regrind	19
Cavity Layout	12	Measuring Residual Stress	19
Runner Systems	12	Extrusion	22
Gating	12	Predrying	22
Sprue gating	12	Extrusion Temperatures	22
Edge gates	13	Screw Design Recommendations	22
Diaphragm gates	13		
Tunnel or submarine gates	13		
Pin gates	13		
Gate location	13		
Venting	14		

Die Design	22
Extruded Product Types	23
Wire	23
Film	23
Sheet	23
Piping and tubing	23
Start-Up, Shut-Down, and Purging	24
Start-Up Procedure	24
Shut-Down Procedure	24
Purging	24
Thermoforming	25
Index	27

Sulfone Polymers

Solvay offers the industry's broadest range of high-performance sulfone polymers. These high-temperature amorphous thermoplastics are inherently transparent and are noted for their strength, rigidity, and outstanding dimensional stability. Continuous use in air or in steam at elevated temperature does not cloud, craze, or otherwise destroy the material's transparency.

The natural color of sulfone resins is a transparent amber, ranging from light to medium. Solvay's new product technology has significantly lowered the color of these materials, approaching water white for specific grades of polysulfone. Sulfone polymers are also available in opaque colors and in mineral-filled and glass-reinforced compounds, which provide improved strength, stiffness, and thermal stability.

Sulfone polymers can be processed following standard methods for injection molding, extrusion, and blow molding. Shapes can be machined for prototype evaluations; film and sheet can be thermoformed on conventional equipment. Plus, you can do most post-fabrication operations such as ultrasonic welding, adhesive bonding, and laser marking as well as heat staking, threading, and machining. Sulfone polymers can also be solution processed to make coatings and membranes.

Udel® Polysulfone (PPSU)

This tough, rigid, high-strength thermoplastic has a heat deflection temperature of 174 °C (345 °F) and maintains its properties over a wide temperature range. Udel® PSU excels in many fluid-handling applications and has over 10 years of success replacing brass in pressurized hot water plumbing applications.

Veradel® Polyethersulfone (PESU)

This resin combines good chemical resistance with a high heat deflection temperature of 204 °C (400 °F), making it a good fit for baby bottles and other food service applications. Because the material is inherently flame retardant, it is also used for electronic components and testing devices.

Radel® Polyphenylsulfone (PPSU)

For severe service applications requiring repeated sterilization or uncompromising toughness, Radel® PPSU really stands out. With a high heat deflection temperature of 207 °C (405 °F), it can withstand continuous exposure to heat and still absorb tremendous impact without cracking or breaking. It is inherently flame retardant and offers exceptional resistance to bases and other chemicals.

Acudel® modified PPSU

These proprietary blends open the door to more cost-sensitive applications that require toughness and chemical resistance as well as hydrolytic and dimensional stability.

Resin Drying

Sulfone polymers will absorb moisture, and although they are hydrolytically stable, they should be dried before processing. Processing wet resin will result in cosmetic defects, such as surface streaks or splay marks on injection molded parts and severe bubbling or streaking in extruded profiles. The moisture does not hydrolyze the polymer or degrade its properties. Parts formed from undried resin are only unsatisfactory in appearance, or in some cases weak due to formation of internal bubbles. Any unsatisfactory parts due to these cosmetic defects can be reground, dried, and then remolded without loss of properties.

Sulfone polymer pellets can be dried in a circulating hot air oven or in a dehumidifying hopper dryer.

Recommended drying times and temperatures for Udel® PSU are:

- 2 hours at 163°C (325°F)
- 3 hours at 149°C (300°F)
- 4 hours at 135°C (275°F)

Recommended drying times and temperatures for Veradel® PESU resins are:

- 3 hours at 177°C (350°F)
- 4 hours at 150°C (300°F)
- 5 hours at 135°C (275°F).

The desired moisture content for injection molding is below 0.05% (500 ppm) and for extrusion below 0.01% (100 ppm). Hopper drying requires sufficient insulation and minimal system leakage. Inlet air temperature must be high enough to maintain a polymer pellet temperature of at least 135°C (275°F), and the dew point of the inlet air should be -40°C (-40°F). These conditions must be sustained long enough for the polymer moisture content to drop to below the minimum levels suggested for the processing technique to be used.

Drying below 135°C (275°F) is not recommended because drying times would be excessive. The drying conditions suggested represent minimums because sulfone polymers cannot be over-dried. In fact, they can be held at 135°C (275°F) for up to a week without harm.

Drying curves for Udel® PSU, Veradel® PESU, and Radel® PPSU are shown in Figures 1 through 3.

Figure 1: Drying Udel® PSU

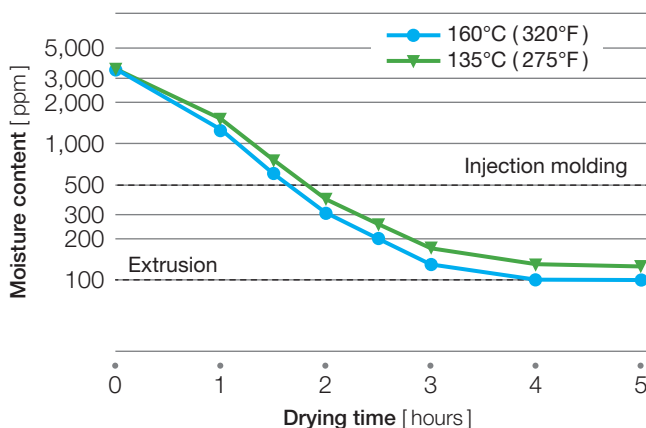

Figure 2: Drying Veradel® PESU

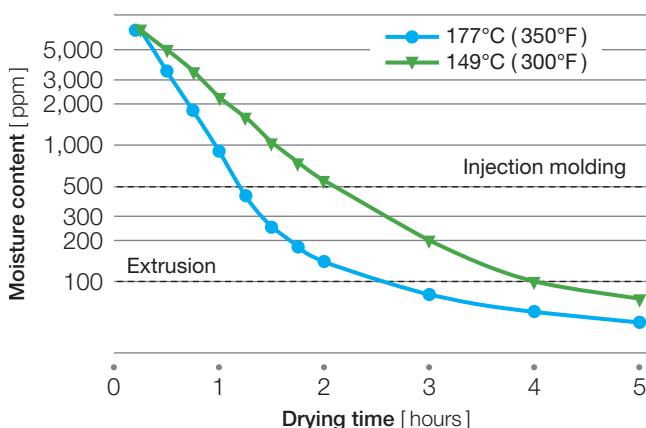
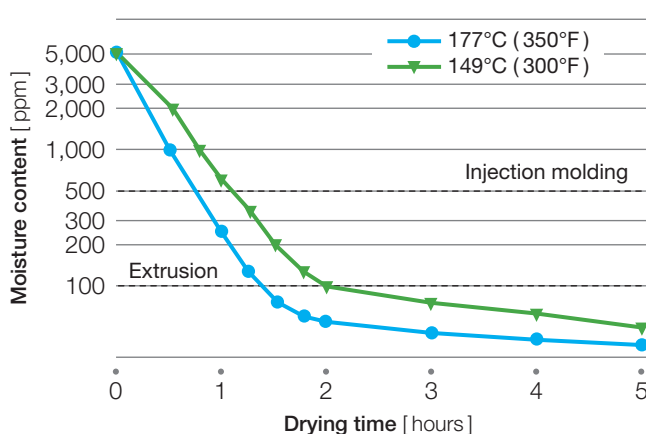

Figure 3: Drying Radel® PPSU



Resin drying time may have to be increased in highly humid weather. An air-tight oven equipped with a dehumidifying unit in which the air is recirculated over a drying bed is recommended as the most uniform and efficient drying method. Dried resin should be placed in sealed containers to maintain dryness.

In continuous molding and extrusion operations, it is recommended that a dehumidifying hopper dryer be attached directly to the processing equipment. These efficient dryers permit continuous processing operations. The dryer should be sized such that residence time of the resin in the dryer is long enough to effectively dry the resin to the desired moisture content at maximum production rate.

Rheology

To assist the fabricator in the proper design of tools and processing equipment, the rheology of the Udel® PSU, Veradel® PESU and Radel® PPSU resins has been measured under a variety of conditions.

Viscosity-Shear Rate

The viscosity versus shear rate data are shown in Figures 4 through 6.

Figure 4: Udel® P-1700

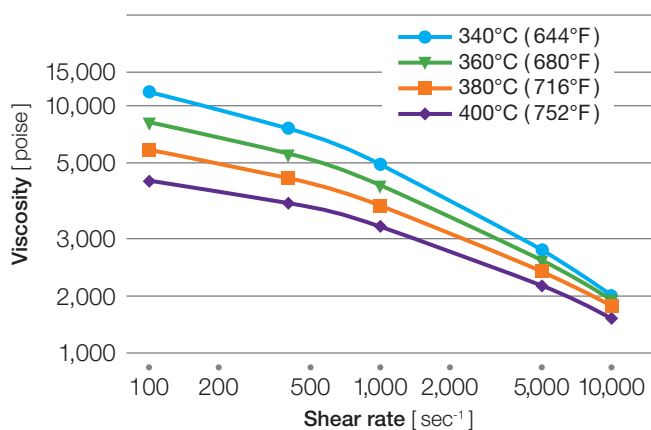

Figure 5: Veradel® A-301

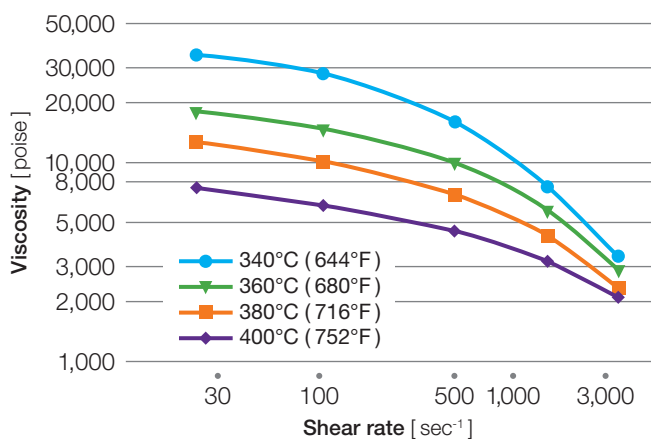
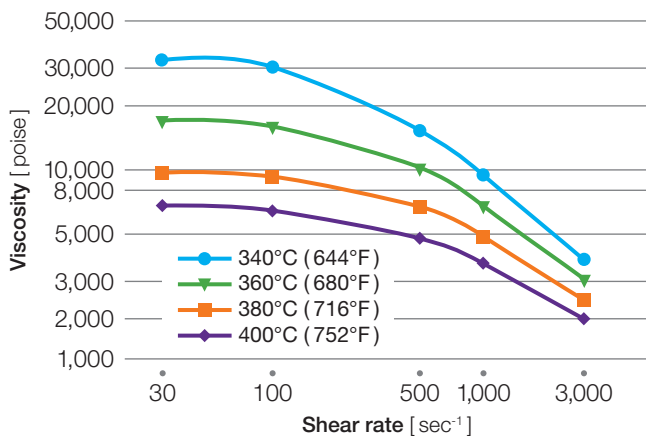

Figure 6: Radel® R-5000



Resin Flow Characteristics

Melt flow index

Another common method for quantifying melt flow is detailed in the ASTM test method D1238, Melt Flow rates of Thermoplastics by Extrusion Plastometer. The values obtained by this method must specify the temperature and load used for the measurement. Table 1 gives the typical flow rates for selected sulfone resin grades.

Table 1: Melt flow rates of sulfone resins (ASTM D1238)

Grade	Temperature [°C]	Load [kg]	Typical Melt Flow Rate [g/10 min.]
Udel® PSU			
P-3500	343	2.16	3.4
P-1700	343	2.16	7.0
P-3703	343	2.16	17.5
GF-110	343	2.16	7.5
GF-120	343	2.16	7.5
GF-130	343	2.16	6.5
Veradel® PESU			
A-201	380	2.16	20.0
A-301	380	2.16	30.0
AG-320	343	2.16	6.0
AG-330	343	2.16	4.5
Radel® PPSU			
R-5500	365	5.0	11.4
R-5000	365	5.0	17.0
R-5800	365	5.0	24.0

Spiral flow

Another method of characterizing material flow is the measurement of the flow length in a spiral cavity at various thicknesses, temperatures, and molding pressures. Spiral flow data for Udel® P-1700, Veradel® A-301 and Radel® R-5000 are shown in Figures 7 through 9.

Figure 7: Spiral flow of Udel® P-1700

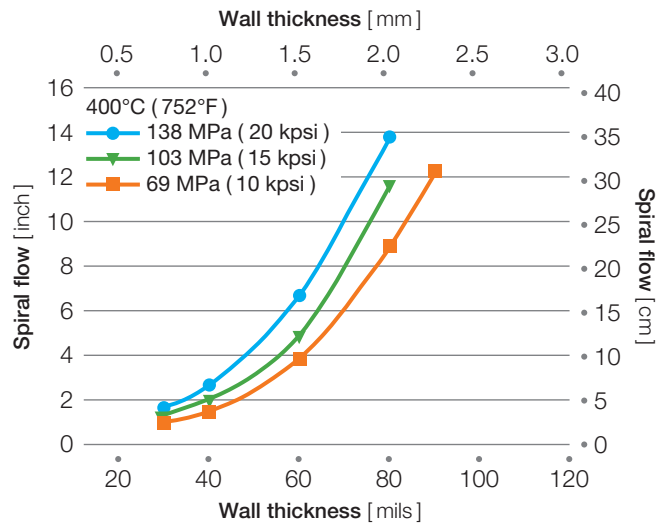

Figure 8: Spiral flow of Veradel® A-301

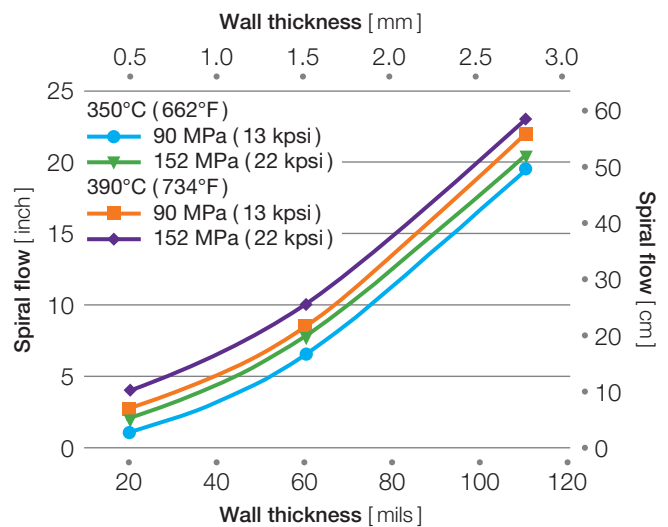
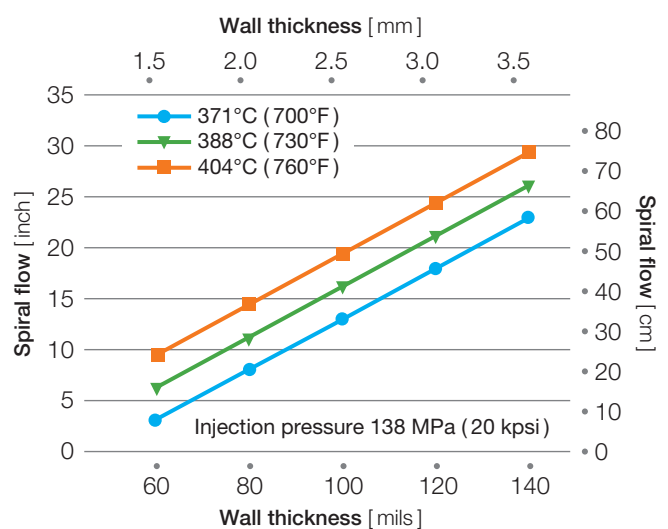

Figure 9: Spiral flow of Radel® R-5000



Injection Molding

Molds and Mold Design

In general, mold design should be as simple as possible. Consideration should be given to part ejection as well as gate location when determining cavity positioning. Thermal management of the mold is also critical. The circulating heat transfer medium should be designed to maintain uniform cavity temperature. Failure to address these issues can result in part ejection problems.

Tool Steels

As with any engineering resin, the number and quality of parts that a tool is expected to produce will dictate the tool steel selection. For high-volume production, the initial expense of high-quality tooling will be a sound investment.

Generally, the common tool steels, such as H-13, S-7, and P-20 are acceptable for constructing injection molds. When molding glass- or mineral-reinforced resins, abrasion resistance is required and H-13 performs best. Soft metals, like aluminum, should be avoided even for prototyping. Tool steel should be hardened prior to production; however, it is wise to sample the mold before hardening so that final dimensional cuts can be made easily.

Mold Dimensions

Determine the general mold dimensions using the shrinkage value for the resin grade being considered (Table 2). For close tolerance parts, it is prudent to cut all mold dimensions “steel-safe”. That is, mold components that will form internal features on the part (cores) should be cut oversized and mold components that will form external features should be cut smaller than the expected dimensions. After the initial material sampling, molded parts can be measured and final mold dimensions can be adjusted to produce the desired part dimensions. The tool can then be hardened.

Table 2: Typical shrinkage values for select sulfone polymers

Grade	Shrinkage [%]
Udel® P-1700	0.6–0.7
Udel® GF-120	0.4
Veradel® A-301 or 3300	0.6–0.7
Veradel® AG-320	0.4
Radel® R-5000	0.6–0.7
Acudel® 22000	0.6–0.7

Mold Polishing

While an excellent surface appearance may not always be required, it is necessary to remove all machining marks from the mold to ensure proper part ejection. All surfaces should be polished in the direction of ejection. Textured surfaces are permitted for cosmetic parts; however, undercuts are not permitted.

Mold Plating and Surface Treatments

Plating of tool steel is not generally required. If a high-gloss, durable surface is required, it may be obtained with a surface treatment such as high-density chrome plating or titanium nitride treatment. Numerous other mold surface coatings and/or treatments are commercially available. While we have not completely investigated all of them, we have not yet found any that offer a significant long-term improvement over high-density chrome or titanium nitride.

Tool Wear

While sulfone based resins are not chemically aggressive toward tool steel, wear and abrasion can occur, especially with the glass and mineral filled grades. Typically, wear will occur in high shear areas of the mold, such as gates, corners, and areas inside the cavity that are initially contacted by the injected resin. When designing the mold, wear should be considered when choosing gate location and cavity layout. The use of gate inserts and easily interchangeable internal cavity components at expected wear locations will minimize downtime for repairs.

Mold Temperature Control

Since the process of thermoplastic injection molding essentially consists of injecting molten resin into a cooled cavity and allowing it to solidify, then ejecting the molded part, it is very important that the temperature of the mold be controlled properly. This is generally accomplished by circulating a heat transfer medium through channels in the mold. Sulfone polymers require mold temperatures greater than 138 °C (280 °F) so a heat transfer oil is required.

Electric cartridge heaters should not be used. Although they have the capability to heat the mold, they cannot remove heat from the mold. Since the polymer being injected into the mold is considerably hotter than the cavity, the excess heat needs to be removed. This is especially true in thermally isolated areas such as core pins where heat may build up and cause ejection problems. Thermally conductive copper-beryllium pins may be inserted into these areas to facilitate heat transfer.

The heat transfer channels in the mold should be located equidistant from each cavity and the flow designed so that each cavity is exposed to the same amount and temperature of fluid. The flow pattern past the cavities should be designed to be concurrent rather than sequential. The internal lines carrying the heat transfer fluid should be sized, within the limits of the available flow rate, to create turbulent flow to maximize heat transfer.

Mold Types

There are several types of molds that can be used to mold sulfone resins. These include two-plate, three-plate, and hot-runner systems. All of these can contain manual or hydraulic slides and other required features.

Two-plate molds

Two-plate, or A-B molds are the simplest and most common of all mold types. They use a stationary A side and a movable B side. The molten resin is injected through the sprue in the A side, along a runner system on the parting line into the mold cavity or cavities, usually cut into the B side.

Because the ejector system is generally designed to eject the molded part from the movable or B side, it is necessary that the part, the sprue, and the runner system remain on the B side when the mold opens. To ensure that this occurs, it is common practice to cut the cold slug well, the runner system, and the majority of the cavity in the B side.

The cold slug well, normally cut into the B side opposite the sprue, has two functions. First, it collects the leading edge of the injected shot, which usually contains a cold slug of resin from the nozzle tip, and prevents that material from entering the mold cavity. Second, by virtue of a slight undercut, the cold slug well will pull the sprue out of the A side as the mold opens. Placing an ejector pin in the B side at the cold slug well will eject the sprue.

To ensure that the molded part itself stays in the movable side on mold opening, it is common practice to have the majority of the part formed in that side. Detail in the stationary side should be kept to a minimum. When it is necessary to have significant detail in the A side, plans for positive ejection out of the A side, such as a spring-loaded ejector system, are advisable.

Three-plate molds

Three plate molds are a modification of the two-plate system in which a center plate is added between the movable and stationary plates. This center plate isolates the sprue and runner system from the parts. The runner system is formed between the stationary and the center plates and the molded parts are formed between the center and movable plates. When the mold opens, the parts remain and are ejected from the movable plate. The runner system and sprue, however, are broken from the molded parts and remain between the center and

stationary plates. A spring loaded ejector system in the center plate ejects the runner.

The runner system is usually cut into the center plate of the mold as well. Ejector pins in the runner system which are partially below the surface, known as sucker pins ensure that the runner stays in the center plate. These sucker pins can contain slight undercuts.

There are several aspects of this system that make it more attractive than the two-plate system. First, degating is accomplished during the part ejection process, not as a secondary operation. Second, there is far greater freedom in selecting the number and the location of the gates by the placement of the gate drops through the center plate. Larger parts may be gated at several locations for ease of filling.

Hot runner molds

In hot runner molds, the plate containing the sprue and runners is replaced with an electrically heated manifold containing channels that carry the molten resin from the barrel to the cavities. The resin in the manifold remains in the molten state. During injection, the molten resin flows into the cavities on the B side directly from the manifold drops, where it is cooled and the part is ejected. Hot runner molds are extremely popular due to their material efficiency. Since no sprue and runner are molded, all of the resin is in the part.

Hot runner molds are often provided as a turnkey system; however, certain aspects of the design are important for successful operation with sulfone resins. The hot runner manifold channels should be free-flowing without sharp corners or flow impediments. Any stagnant resin will tend to thermally degrade due to excessive residence time and contaminate the melt and the parts.

The temperature control of a hot runner mold is critical. Excessive residence time in the manifold should be avoided as it can result in material degradation. Separate temperature controllers for each drop on the manifold must be used. The controlling thermocouple for each heat source in the manifold should be close to the resin and between the heat source and the resin. In addition the flow path must be unrestricted with no internal mechanisms or channels. Flow restrictions will increase the shear on the material and may result in discoloration and degradation of the resin.

Cavity Layout

In any multi-cavity mold, a balanced cavity arrangement is critical to molding quality parts. This means that all of the cavities must contain the same volume and fill at the same time. An unbalanced mold will over-pack some cavities while others are under-packed. A balanced mold fills all cavities at the same rate with the same pressure, ensuring uniform parts. Usually, this is accomplished by placing the cavities equidistant from the sprue with identically sized runners. The flow path should have the same length to each cavity.

Family molds are sometimes constructed to mold two or more different shaped parts in a single mold. This type of mold is often impossible to balance and should be avoided. When economics require that different cavities be placed in a single mold base, the runner system should be balanced to each cavity and be equipped with cavity shutoffs. If acceptable parts cannot be molded together, cavity shutoffs allow each part to be molded individually.

Runner Systems

The purpose of the runner system is to provide a channel connecting the sprue and the cavity. To avoid wasting the material in the sprue and runner system, the sprue and runner are generally ground and reused. Typically mixing 25 % ground sprues and runners with 75 % virgin resin is allowed. Therefore, the most material-efficient mold design will be achieved when the sprue and runner weight is no more than 25 % of the total shot weight.

Reducing the weight of the runner can be accomplished by minimizing both the length of the runner and the runner surface-to-volume ratio. A full round runner has the lowest surface-to-volume ratio. It is the most efficient runner, but is difficult to fabricate. A trapezoidal runner with a 10 % slope increases the weight of the runner system by about 25 %, but is considerably easier to machine. The size of the runner will depend on the length of the flow path and the grade of resin being used. In all cases, the thickness of the runner should be larger than the thickest section of the part to ensure that the runner does not freeze off before the part is fully densified.

When a runner splits to fill two or more cavities, the total area of the secondary runners should be no greater than the area of the primary runner. This will ensure that the velocity of the melt front is not decreased.

Cold slug wells should be used at every turn in the runner system as well as at the base of the sprue. These wells will serve to remove the leading edge of the advancing melt and prevent the introduction of cold material into the cavity.

Since the material in the runner system is usually re-used, the runner system should be well-vented to prevent burn marks. Venting the runner will also allow the gas in the runner to exit out of the runner rather than through the part cavities.

Keeping the runner system on the proper plate during mold opening can be accomplished with sprue pullers and sucker pins that provide slight undercuts. Generous ejector pins on the runner system will ensure positive ejection from the mold.

Gating

All conventional gating types are suitable for processing sulfone resins, including hot runner systems. The considerations for selecting a gating method should include gate location for optimal densification, gate removal method, generation and use of regrind, and cosmetic requirements.

The dimensions of a gate depend on several factors, including the size of the part, its thickness, the type of gate being used, and the grade of resin. In general, the smallest gate dimension should be at least 50 % of the wall thickness at the point being gated into to ensure optimum densification. If the gates are too small, parts may be under-packed, shrink erratically, have internal porosity or sink marks, and have poor mechanical performance.

Sulfone resins have a high viscosity and do not shear thin during the injection process. Therefore, it is important to radius sharp edges in the gate area, wherever possible.

Sprue gating

Sprue (direct) gating is most often used with hot runner systems and is often used on prototype molds as well. This method places the mold cavity directly in line with the sprue or under the hot runner drop. The major advantages of this method include system simplicity and minimized runner volume and flow length. The disadvantages of sprue gating include the potential for cold slugs to be visible on the part and the need to remove the sprue or hot runner vestige. This generally involves a post-machining operation or a manual operation by the operator at the press.

Edge gates

Edge gates are by far the most common gate type. These gates are used with a conventional sprue and runner system. The runner introduces the resin to the mold cavity along the parting line. Cold slug wells are placed in the runner system to keep cold slugs out of the parts. An undercut is generally placed in the movable side of the mold to act as a sprue puller. Rectangular edge gates should be 1.5 to 2 times as wide as they are deep and proportional to the part thickness.

Advantages of edge gates include ease of fabrication, modification, maintenance, and trouble-free operation. Cold slug wells eliminate cold slugs in parts. The disadvantage of this gating method is the generation of scrap, some of which may be ground and reused. Gate inserts are strongly recommended for ease of gate replacement if excessive wear occurs.

Diaphragm gates

Diaphragm gating is used almost exclusively for molding circular parts without knit lines. A high degree of flatness can also be attained with this method when using a fiber-reinforced grade that may be prone to warpage when using other gate types. Similar to sprue gating, a machining operation will be required to remove the gate.

Tunnel or submarine gates

Tunnel or submarine gating is another popular method because it is self-degating. Tunnel gates employ a conventional parting line runner system similar to a standard edge gate. In close proximity to the mold cavity, however, the runner tunnels beneath the parting line and gates into the part below the mold parting surfaces, as illustrated in Figure 10. Upon ejection, the molded part and runner/gate are separated by the tool steel itself. The angle of the drop is critical in ensuring that the runner will eject properly and not become stuck in the mold. Unfilled sulfone resins typically work well with an angle of 45 degrees perpendicular to the parting line of the mold. Glass filled grades with a higher modulus may require a more-severe drop angle, closer to 30°.

The main advantage of tunnel gates is the automatic degating feature. A potential disadvantage is the possibility of an irregular gate vestige and high shear. Gate inserts are strongly recommended for use with tunnel gates.

Tunnel gates should be a minimum 1 mm (0.04 inch) on the minor axis, increasing in size for larger parts.

Figure 10: Tunnel gates

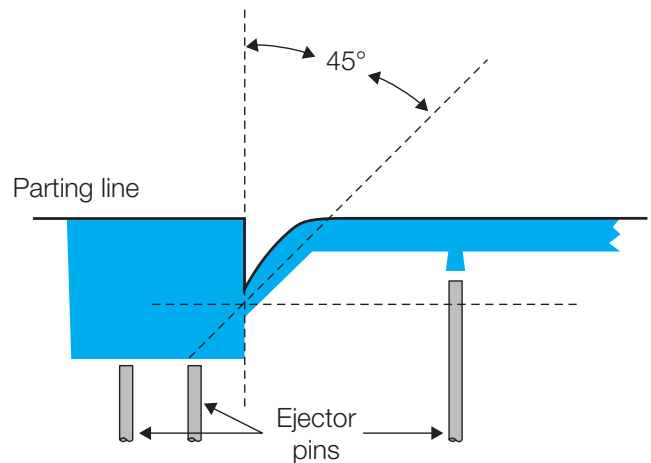

Pin gates

Three plate molds should use proportionally sized gates, but no less than 1 mm (0.04 inch) in diameter for small parts and no more than 3.2 mm (0.125 inch) in diameter for large parts. Very large gates used with three plate molds may cause degating problems.

Gate location

Gates should always be located in the thickest section of the part to allow flow from thick to thin sections. Cosmetic considerations may dictate gate locations; however, it is inadvisable to flow through a thin section to a thicker section. Other factors that may influence gate location include knit line location, flatness requirements, and the number of gates required to fill the part.

Venting

Vents in a mold cavity, as shown in Figure 11, allow the gas (air) present in the cavity to escape from the cavity as the resin fills. Inadequate venting may result in the gas being compressed in the cavity, which may then heat up to the point of causing burn marks on the part and a deposit on the mold surface. This is known as dieseling. Poor venting may also result in poor weld line strength and the inability to completely fill the cavity.

Vent location depends on the cavity layout, and can be accurately predicted by flow simulation. Short shots can also be used to find areas for venting. In general, vents should be placed opposite the gate, at expected knit lines, and at various locations on the parting line, such that the total volume of vents is equal to about 25% of the cavity perimeter. Venting below the parting line can be accomplished by incorporating vents at ejector pins. Venting on core pins and in deep cavities also assists part ejection by breaking the vacuum formed and preventing part warpage.

If production runs are often interrupted to clean deposits from the mold, additional or deeper vents may solve the problem.

Figure 11: Standard vent dimensions

Width: 3.2 mm (0.125 in) minimum

Land length: 0.8 mm (0.30 in) minimum
to 1.6 mm (0.60 in)

Relief channel depth: 1.3 mm (0.50 in) minimum

The relief channel should extend to the edge of the tool.

Vent depth will vary with melt flow

For high flow grades

Depth: 0.2 mm (0.001 in) to 0.05 mm (0.002 in)

For low flow grades

Depth: 0.08 mm (0.003 in) to 0.10 mm (0.004 in)

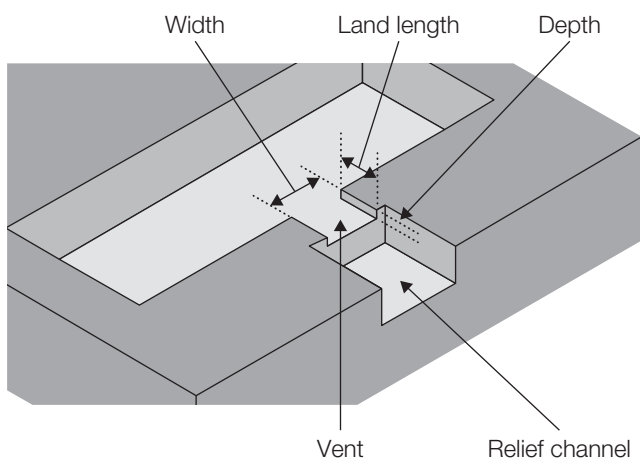

Part Ejection

Draft

To aid in the release of the part from the mold, parts are usually designed with a taper in the direction of mold movement. The taper creates a clearance as soon as the mold begins to move, allowing the part to break free. The taper is commonly referred to as “draft,” and the amount of taper referred to as “draft angle.” As a rule, the draft on injection molds for sulfone resins should be 1° to 2°.

Ejector pins and/or stripper plates

The area of ejectors or stripper plates should be as large as possible. Ejector pins must not be too thin, or they may press into the parts and deform the parts during rapid cycling or at high mold temperatures.

Injection Molding Equipment

Controls

The injection molding machine should be capable of controlling the injection portion of the process by velocity and screw position. Most machines made after 1980 have this capability. Older machines can be retrofitted with linear transducers and electronic controllers. It is desirable if the press controls include the capability to monitor and allow alarms to be set for the following process variables: injection time, cushion, and hydraulic pressure at transfer position.

Clamp

Choose a press that provides a clamp pressure of at least 4 tons per square inch (8 kpsi, 545 bar, or 55 MPa) of projected part area.

Barrel Capacity

The barrel capacity should be between 1.5 and 3.3 times the shot size. A press of this size minimizes residence time in the barrel, because each shot will use 30% to 60% of the barrel capacity.

Press Maintenance

Injection molding machines need to be properly maintained. The barrel to screw clearance should be monitored regularly to make sure it is still conforms to the manufacturers specification. The check ring should routinely be checked for excessive wear.

Screw Design

The typical general-purpose screw will perform satisfactorily with sulfone resins. A typical screw design for processing the sulfone engineering resins is shown in Figure 12.

Figure 12: Screw design for injection molding

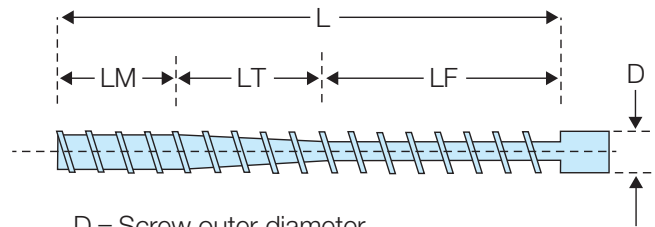

D = Screw outer diameter	
L = Overall screw length	18 - 22 D
LF = Length of feed section	0.5 L
LT = Length of transition section	0.3 L
LM = Length of metering section	0.2 L
CR = Compression ratio	1.8 - 2.4 : 1

Screw Tips and Check Valves

The design of the screw tip and the check valve are important for proper processing. The check or non-return valve keeps the melt from flowing backwards over the screw flights during injection and holding. If no check valve is used, it will be difficult or impossible to maintain a consistent cushion.

The check valve or check ring system must be designed for smooth flow, avoiding dead spots or back pressure. Ball check valves are not recommended. The screw tip should also be streamlined to ensure that the amount of stagnant melt in front of the screw is minimized.

Nozzles

Open nozzles are preferred to nozzles equipped with shut-off devices. Nozzles should not be reversed tapered. General purpose or full taper nozzles are acceptable.

At least one band heater (rated at 200W to 300W) is required for the nozzle, where heat losses to the mold may be severe. Nozzle heat loss can be reduced by insulating the nozzle. Ceramic band heaters are recommended. Ceramic heaters are better suited for high temperature use, can provide a higher watt density than Mica band heaters, and typically last longer.

Molding Process

For this discussion, the molding process can be envisioned as three distinct steps:

- Polymer injection or mold filling
- Packing and holding or part densification
- Cooling and screw recovery

Polymer Injection or Mold Filling

The mold-filling step is the portion of the cycle at high injection pressure; it ends when the pressure is reduced to the lower hold pressure. This step of the process can be controlled using a variety of process control methods.

These include controlling the time at a constant injection pressure, controlling the injection rate until the screw position reaches a set point, transferring to hold pressure on cavity pressure, or transferring to hold pressure at peak hydraulic pressure.

The most common method is to control the injection rate or velocity, and to switch to hold pressure at a set screw position or transition point. The advantage of this method is that a controlled volume of resin is being delivered to the cavity at a specified rate. Generally, medium to slow injection rates are recommended.

To use this method, the proper screw position for switching from injection pressure to hold pressure must be determined. This position should be such that the part is about 95% filled; the remainder of the part should be filled and packed out with hold pressure. This method should allow any remaining gas in the tool to be vented without burning. An efficient method for determining the correct screw position for the transition to hold pressure is as follows:

1. Set holding (low) pressure to zero.
2. Set screw forward (injection) velocity to 1 cm/sec to 5 cm/sec (0.5 in./sec to 2 in./sec).
3. Mold several shots and observe the parts. The objective is to find the screw position at which the part will be almost filled but not packed out.
4. If the parts appear completely filled, move the transition point numerically higher (smaller shot volume).
5. If the parts are very short, adjust the transition point numerically lower (larger shot volume).

This transition set point will produce a part that is nearly filled but not packed out. Once the appropriate transition set point has been determined, packing or hold pressure should be applied to complete the filling and pack the part out.

Cavity pressure can be used to trigger the transfer to hold pressure. The success of this method is dependent on the correct placement of the pressure transducers in the cavity. Transducers should be placed in the last-to-fill area of the cavity.

If velocity and position controls are not available, hydraulic pressure and timers should be adjusted to fill the part in 2 to 5 seconds.

Packing and Holding

The filling of the mold cavity with polymer is completed during the packing and holding portion of the process. The continued application of pressure achieves maximum part density. The variables are hold pressure and time.

The injection pressure is a function of the injection rate. The pressure required to achieve that rate or the pressure at the transition point should be observed and the hold pressure should initially be set to one-half of that value. The hold pressure should be as high as possible without flashing the cavity to ensure optimum densification of the molded part.

The hold time will depend upon a number of factors, including the thickness of the part, the gate dimensions, the mold temperature, and the resin solidification rate. The best way to determine the hold time is experimentally. Weigh parts until increasing the hold time does not increase the part weight. Lack of full densification in molded parts may result in performance problems including warpage, uneven shrinkage, and sinks or voids.

Cooling

During the cooling step, the part becomes stiff and strong enough to be ejected without warpage and/or deformation from the ejector pins. Simultaneously, the screw rotates, plasticizing material for the next cycle. The speed at which the screw rotates should be between 60 rpm and 100 rpm, with just enough back pressure to ensure a uniform shot size.

If long cooling times are used, the polymer's residence time in the barrel can become excessive, resulting in polymer degradation. A screw delay (added time interval between the end of Pack/Hold and screw recovery) can help to minimize degradation.

Machine Settings

Barrel Temperatures

Starting point barrel melt temperatures for injection molding the sulfone resins are listed in Table 3. The most important measure is the actual melt temperature. Barrel temperatures should be adjusted to achieve the desired melt temperature. The melt temperature should be checked with a handheld pyrometer by inserting a probe in an air shot patty. The probe should be preheated to about 425 °C (800 °F) with a torch or lighter, just prior to insertion into the melt patty, otherwise the reading will be lower than the actual temperature. The temperature should be checked after initial purging of the barrel and then verified after about 6 to 10 shots once the machine is in a regular cycle.

In general, higher temperatures should not be used, because of the risk of thermal degradation. As a fundamental rule, melt temperatures higher than 395 °C (740 °F) should be avoided.

Sulfone pellets can be melted under mild conditions. If the barrel temperature settings increase from the hopper to the nozzle, relatively long residence times can be tolerated. If residence times are short and higher temperatures are needed to achieve the desired melt temperature, the same temperature can be set on all the barrel heaters. The band heater control system should be monitored and alarmed. For instance, a timely alarm may prevent screw breakage if a heater fails in one of the barrel sections.

Feed throat bridging can be prevented by maintaining the temperature in the vicinity of the hopper at about 80 °C (175 °F) by using the feed throat cooling jacket. If the temperature in the feed section is set too high, the pellets may melt prematurely, resulting in the screw flights becoming clogged and bridged over.

Mold Temperature

The mold temperature is an important factor in determining part shrinkage, warpage, part dimensional tolerances, the quality of the molded part finish, and the level of molded-in stresses.

The mold temperature for sulfone resins is usually set in the range of 120 °C to 160 °C (250 °F to 320 °F), preferably 138 °C (280 °F) or higher. The glass-reinforced grades require higher temperatures to achieve an optimum surface finish. Table 3 lists the recommended mold temperatures for the main sulfone grades.

Insulation plates should be placed between the mold and the platen to reduce heat loss and improve mold temperature control. High quality molded parts require a well-designed system of cooling channels and correct mold temperature settings.

Residence Time in the Barrel

The length of time the plastic remains in the barrel has a significant effect on the quality of the injection molding. If it is too short, the pellets will not be sufficiently melted. If it is too long, thermal degradation is likely and is indicated by discoloration, dark streaks, and even burned particles in the molded parts. Frequently, the residence time can be reduced by using a smaller injection unit. Acceptable residence times will be obtained if the shot size is 30% to 70% of the barrel capacity. At the melt temperatures listed in Table 3, all the sulfone resins can tolerate a residence time of 10 to 20 minutes.

Injection Rate

The injection rate used for filling the mold is another important factor in determining the quality of the molded part. Moderate injection speed should be used; it should be rapid enough to achieve melt homogeneity, but slow enough to avoid shear burning. Fill times are typically 2 to 5 seconds for unfilled grades. A faster injection rate provides uniform solidification and good surface finish, especially with the glass-reinforced grades.

Back Pressure

Back pressure is usually employed to maintain a constant plasticizing time, to avoid air entrainment, and to improve the homogeneity of the melt. While some back pressure is generally beneficial, back pressure that is too high can result in high frictional heating. Typical back pressure is 100 psi to 300 psi (0.7 MPa to 2.1 MPa).

Screw Speed

Whenever possible, the screw speed should be set so that the time available for cooling during the cycle is fully utilized. In other words, the longer the cycle time, the slower the screw speed. For instance, a screw speed of 60 rpm to 100 rpm often suffices for a 50 mm (2 inch) diameter screw. This is particularly important, when running high melt temperatures to ensure that the melt does not remain stationary for an undesirably long time in the space in front of the screw tip. Low screw speeds also diminish the temperature increase due to friction.

Shrinkage

Shrinkage is defined as the difference between the dimensions of the mold and those of the molded part at room temperature. It is primarily a property of the thermoplastic resin and results from the contraction in volume that occurs when the molding compound cools within the mold. Other factors that effect the magnitude of the shrinkage are the geometry of the part, the wall thickness, the size and location of the gates, and the processing parameters. The interaction of all these factors makes it difficult to predict shrinkage exactly, but close estimates of typical values appear in Table 2. Since sulfone resins are completely amorphous, shrinkage is uniform in both the flow and transverse direction.

Table 3: Recommended starting point processing conditions for select sulfone polymers

	Unit	Udel® P-1700	Udel® GF-120	Veradel® A-301, 3300	Veradel® AG-320	Radel® R-5000	Radel® 22000
Temperature							
Feed Zone	°C (°F)	350 (660)	355 (670)	355 (670)	360 (680)	365 (690)	365 (690)
Middle Zone	°C (°F)	355 (670)	360 (680)	360 (680)	365 (690)	370 (700)	370 (700)
Front Zone	°C (°F)	360 (680)	365 (690)	365 (690)	370 (700)	375 (710)	375 (710)
Nozzle	°C (°F)	357 (675)	363 (685)	363 (685)	368 (695)	374 (705)	374 (705)
Melt Target	°C (°F)	360 (680)	365 (690)	365 (690)	370 (700)	375 (710)	375 (710)
Mold	°C (°F)	138–160 (280–320)	138–160 (280–320)	138–160 (280–320)	138–160 (280–320)	138–160 (280–320)	138–160 (280–320)

Regrind

Sprues, runners, and discrepant parts can be reused by grinding them and mixing them with pellets. The ground material, often referred to as regrind, must be dry. It can be dried using the same procedure used for pellets, but may require additional time due to particle geometry. Sulfone resins have excellent thermal stability and regrind can be used multiple times without degradation. A typical regrind utilization scheme is to mix 25% regrind with 75% pellets.

Measuring Residual Stress

When working with fabricated sulfone parts, it is important to minimize residual or molded-in stress. A procedure has been developed for estimating the magnitude of the residual stress. The procedure entails exposing the parts to a series of chemical mixtures. The stress level required for crazing to occur for each mixture was determined using specimens at known stress levels. The mixtures and the stress levels at which they cause crazing are shown in Table 4 for Udel® PSU and in Table 5 for Radel® PPSU. Contact your Solvay representative for assistance with Veradel® PESU.

Table 4: Residual stress testing for Udel® PSU

Ethanol/Ethyl Acetate Ratio	Critical Stress for Udel® P-1700 [MPa (psi)]
75/25	19 (2800)
50/50	15 (2200)
43/57	12 (1700)
37/63	9 (1300)
25/75	6 (800)
0/100	3 (400)

Table 5: Residual stress testing for Radel® PPSU

Ethanol/MEK Ratio	Critical Stress for Radel® R-5000 [MPa (psi)]
50/50	23 (3300)
45/55	16 (2300)
40/60	15 (2200)
25/75	14 (2000)
10/90	9 (1300)
0/100	8 (1200)

For example, to determine the residual stress of a Udel® PSU part, immerse the part for one minute in the first mixture, 75% by volume ethanol and 25% by volume ethyl acetate. Then remove the part from the reagent and allow to dry. Drying can be accelerated by blowing low-pressure compressed air on the surface.

Then inspect the part for crazes. If the part is crazed, the residual stress is greater than 19 MPa (2,800 psi). If the part is not crazed, the residual stress is less than 19 MPa (2,800 psi). The test is continued with the next mixture.

Immerse the part in the second mixture, remove after one minute, allow to dry, and inspect for crazing. If crazing occurs, the residual stress is between 15 MPa and 19 MPa (2,200 psi and 2,800 psi). If crazing does not occur, the residual stress is less than 15 MPa (2,200 psi). The test is continued with the next mixture.

Continue in a like manner until crazing occurs, or the part endures the one-minute immersion in the last mixture without crazing.

This test has to be conducted on room temperature parts. If testing during production, make sure the part has cooled completely prior to testing.

To maintain accurate stress readings, the reagents must be fresh. Over time, the reagents may absorb water, evaporate, or become contaminated, which can lead to erroneous stress indications. Although reagents can be calibrated by using samples with known stress levels, it may be more practical to replace your reagents with fresh solvent from the sealed container periodically. If you want to calibrate your reagents, contact your Solvay representative for assistance.

Troubleshooting guide for sulfone polymers

Problem	Ensure Resin Dryness	Use Mold Release Grade	Process Parameters												
			Back Pressure	Cooling Time	Hold Pressure and Time	Injection Speed	Injection Time	Injection Pressure	Melt Decompression	Melt Temperature	Mold Temperature	Nozzle Temperature	Screw Speed	Shot Size	Sprue Break
Mold flash						3-		2-		4-					5-
Slow injection						2+		1+		3+	4+				
Erratic injection			1+							2+					
Nozzle plugs										3+	4+	1+			5
Sprue sticks				6+	4-	3-	7-	5-		9-	8-	2+			
Screw squeals			1-							2+			3-		
Slow screw recovery			2-							3+			1+		
Nozzle drool									3+	2-		1-			
Splay	1		3-			2-				5-		4-			
Short shots			8+	4+	2+	9+	3+			6+	5+	7+		1+	
Jetting					1-		4-			2+	3+				
Sinks and voids				4+	7+	2+	3+			5-	6±			1+	
Parts stick	8		3+		2-	4-	1-			6-	5-				
Rippled surface	9				1+		4+			3+	2+				
Dark streaks			3-			4-				2-		1-	5-		
High shrinkage				3+				2+		4-	5-			1+	
Weld lines					4+		3+			1+	2+				
Warping			2+	1+			5+			4-	3-				
Low gloss					3+		4+			2+	1+				
High mold stress	7				3-		5-			2+	1+				
Gate blush					1-		4-			3+	2+	5+			

Apply the remedies in numerical order: + Increase, - Decrease, ± Increase or Decrease

Troubleshooting guide for sulfone polymers

Tooling and Equipment

Problem	Increase Cavity Venting	Increase Clamp Pressure	Increase Draft	Increase Gate Size	Increase Runner Size	Part Wall Thickness	Change Gate Location	Clean and Polish Mold	Insulate Nozzle	Nozzle Orifice	Polish Sprue Bushing
Mold flash		1									
Slow injection				6	7					5+	
Erratic injection											
Nozzle plugs									2	6+	
Sprue sticks											1
Screw squeals											
Slow screw recovery											
Nozzle drool										4-	
Splay											
Short shots	11			12	13	14+				10+	
Jetting				6			5				
Sinks and voids	10			8	9	12-				11+	
Parts stick			9					7			
Rippled surface	7			5		8+				6+	
Dark streaks	7			8						6-	
High shrinkage				6							
Weld lines	5			6							
Warping				6							
Low gloss	6							5			
High mold stress				4						6+	
Gate blush				6							

Apply the remedies in numerical order: + Increase, - Decrease, ± Increase or Decrease

Extrusion

Sulfone resins can be readily extruded on conventional extrusion equipment.

Predrying

Sulfone resins must be dried until the moisture content is below 100 ppm prior to extrusion to prevent bubbles in the extrudate. Please refer to the section on resin drying on page 2.

Extrusion Temperatures

The starting point extrusion temperatures are shown in Table 6.

Table 6: Extrusion temperatures

	Udel® PSU	Radel® PPSU Acudel® mod. PPSU
Melt temperature range	315 °C–371 °C (600 °F–700 °F)	343 °C–400 °C (650 °F–750 °F)
Barrel temperature settings		
Feed end	302 °C (575 °F)	330 °C–370 °C (625 °F–700 °F)
Head end	315 °C–337 °C (600 °F–640 °F)	330 °C–370 °C (625 °F–700 °F)

If a screw with a relatively shallow metering section is used, higher barrel settings may be necessary to better control the operation within the pressure and power limitations of the equipment.

Screw Design Recommendations

In general, screws with length-to-diameter ratios from 20:1 to 24:1 are recommended. Compression ratios from 2.0:1 to 2.5:1 have been shown to give acceptable results. Screw pitch should equal screw diameter, and the transition from feed to metering should be gradual. The transition and metering sections should be longer than the feed section. The transition section should be the longest to provide sufficient time and heat input to adequately soften the resin before trying to pump it. A starting point configuration is 6 flights feed, 12 flights transition, and 6 flights of metering.

Two-stage screws can also be used to allow vacuum venting where optimal compaction of the melt is desired. A two-stage screw design includes a decompression section to allow vacuum venting after the first metering section. The decompression section is then followed by another transition zone and another metering zone, following the design principles described for the single stage screw.

Generally, screw designs intended for polyolefins will not give acceptable results with sulfone resins.

Die Design

The die heaters must be capable of reaching and maintaining temperatures of 430 °C (800 °F). Since the viscosity of sulfone resins is temperature-sensitive, die temperature must be closely controlled to provide a uniform extrudate. Insulating the adapter and die is suggested to improve temperature control and thermal uniformity.

Streamlined dies should always be used. Streamlining the flow channel and incorporating purge plates (i.e., bleeder plugs) in the ends of sheeting dies eliminate the possibility of melt stagnation in the die.

Dies should be capable of operating continuously at pressures up to 240 bar (3,500 psi). Flow channels, die lips, and lands should be highly polished and chromium-plated for optimum extrudate appearance.

Extruded Product Types

Wire

Sulfone resins can be extruded onto wire using a semi-tubing or tubing crosshead die. Wire inlet temperatures should approximate that of the polymer melt. High drawdown of the polymer melt tube can be achieved with sulfone resins. Vacuum on the crosshead is highly recommended to improve adhesion of the polymer tube to the wire. Coated wire should not be quenched but rather cooled slowly using a mister or short water bath.

Film

The high melt strength of sulfone resins provides excellent drawdown properties for the production of thin film. Slot-cast film possesses high modulus, good impact strength, and good electrical properties over a wide temperature range. The film is heat sealable and can be printed without pre-treatment.

A typical film extrusion configuration for a 64 mm (2.5 inch) extruder is:

- **Die:** Standard film dies of coat hanger design and straight manifold-choker bar design are satisfactory. Die lip openings of 1 mm to 1.5 mm (0.025 inch to 0.040 inch) should be used for 0.025 mm to 0.250 mm (1 mil to 10 mil) film. Dies must be capable of continuous operation at 3,500 psi (240 bar).
- **Breaker plates/screenpacks:** Breaker plates are not required and can cause die lines. But when they are used with a screen pack, a consistent, defect-free extrudate can be produced.
- **Casting roll:** Smaller diameter rolls, less than 25 cm (10 inch) are preferred for sulfone polymers because of the high roll temperatures, 180 °C (350 °F), needed. Smaller rolls allow better temperature control and more uniform temperatures across the roll stack.

Sheet

Standard round and teardrop manifold sheet dies with choker bars are satisfactory. Typically, die openings are 10% to 20% larger than the desired final thickness. In sheet extrusion, the take-off roll temperature must be maintained high enough to prevent curl and to minimize strains in the sheet. Either a wrap technique or straight-through calendaring technique is satisfactory, providing that roll temperatures of 180 °C to 230 °C (350 °F to 450 °F) can be obtained. Calendaring also requires that a small bank (melt bead) be maintained at the roll nip.

A power shear has been used to cut the sheet to length for sheet thicknesses up to 2.5 mm (0.1 inch). For greater thicknesses, sawing is recommended.

Piping and tubing

Sulfone resins can be extruded into pipe and tubing using standard pin and spider assemblies. Control of stock temperature is critical to achieving high-quality extrudate. Stock temperatures of 340 °C to 370 °C (650 °F to 700 °F) are suggested.

Sizing plate and vacuum tank methods of dimensional control are satisfactory. For best melt control, the extrusion die should be 70% to 100% larger than the sizing die.

For high-quality extrusion, stress due to processing must be minimized. This is accomplished by minimizing the level of cooling in the vacuum-sizing bath while maintaining dimensional requirements. To this end, a short water bath ($\frac{1}{4}$ to $\frac{1}{5}$ the length of that typically used for polyethylene) is desirable.

The relationship of time in the cooling bath and residual stress levels at various wall thicknesses is shown in Figure 13.

Figure 13: Cooling time vs. residual stress level in Udel® PSU pipe

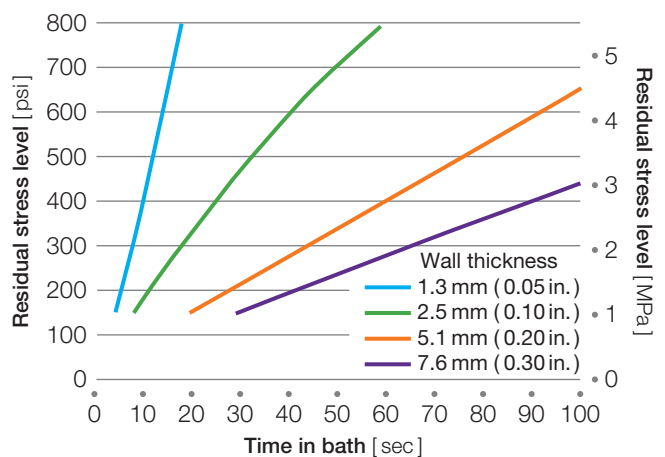

Start-Up, Shut-Down, and Purging

Start-Up Procedure

If processing less thermally stable polymers prior to running sulfone resins, it is critical to completely purge out all of the previous polymer. If needed this can be done in a step-wise fashion by bringing the barrel up to an intermediate temperature, 288 °C (550 °F) and purging with material such as high-density polyethylene (HDPE). Then continue to bring the barrel temperatures up to sulfone temperatures, while continuing to slowly turn the screw and trickle in HDPE until temperatures reach 316 °C (600 °F). Begin to slowly feed the sulfone material. Continue a slow purge until completely switched over to the sulfone resin.

Shut-Down Procedure

If a shut-down is required during an extrusion run, certain precautions should be taken. It is not good practice to allow resin to sit stagnant in an extruder for prolonged periods of time at extrusion temperatures. Some decomposition is likely to occur, and it may prove difficult to start again and properly purge the machine.

If the shut-down is of a short duration (two hours or less), purge the extruder dry, and then restart using starve feed. For longer shut-downs, the extruder should be purged with Udel polysulfone, and then run dry. The extruder heaters should be turned off and allowed to cool to room temperature. To start-up the next day, turn on the die heaters at least one hour, but preferably two hours, before turning on the extruder heaters. Once the extruder reaches 315 °C to 343 °C (600 °F to 650 °F), the screw can be rotated periodically until extrusion temperatures are reached. Start by starve feeding at low screw speeds until material comes out of the die.

Purging

Sulfone resins can be purged from extrusion processing equipment by a variety of techniques. Because sulfone resins are tough, stable, high-temperature materials, the most effective purging procedures replace the sulfone resin with a lower temperature plastic that is more easily removed. The generally recommended purging material is polyethylene, but suitable commercial purging compounds can also be used.

The most effective procedure is a step-wise temperature reduction while purging with a fractional melt-flow, high-density polyethylene. Upon completion of the sulfone resin extrusion, the machine should be slowly run dry of material while the temperatures are brought down to around the 316 °C (600 °F) range. When the barrel has run dry introduce the polyethylene and extrude until no sulfone resin is evident in the extrudate. At this point the die, adapter, and breaker plate can be removed and cleaned. If needed, continue to drop the temperatures to around 288 °C (550 °F) while slowly purging with polyethylene until no evidence of sulfone resin is seen in the extrudate. At this point stop the extrusion and allow the material to sit in the barrel for several minutes, then purge dry the polyethylene and pull the screw for final cleaning if needed. Temperatures can be lowered for shut-down or setup for the next material.

When purging is complete and the extruder has been run to an empty condition, the screw can be removed and both the barrel and screw brushed clean. If residual sulfone resin can not be removed by brushing, it can be burned off using proper care. An alternative technique is soaking the parts in N-methyl pyrrolidone (NMP) until the residual resin is softened enough for easy removal.

Thermoforming

Sheet product must be dried in a hot air or desiccant oven before thermoforming. Sheet is typically hung or positioned in a vertical racking system that allows at least 6 mm (0.25 inch) spacing. Sheet should not be stacked. Oven temperature is critical and needs to be monitored throughout the oven space. Udel® PSU sheet should be dried at 140 °C (285 °F), and Radel® PPSU sheet should be dried at 174 °C (345 °F) according to Table 7.

Table 7: Sheet drying times for sulfone resins

Sheet Thickness [mm (in.)]	Drying Time [Hours]
0.8 (0.032)	4
1.6 (0.064)	8
3.2 (0.125)	12
3.8 (0.150)	16
5.1 (0.200)	20
6.4 (0.250)	24

Drying time will depend on ambient conditions of sheet storage, times may be longer if sheet has been in particularly humid conditions. It is also important for maintaining sheet dryness to only remove the number of sheets that can be formed in about 30 minutes.

The actual Udel® PSU sheet temperature at the surface must be 232 °C to 260 °C (450 °F to 500 °F) for thermoforming. For Radel® PPSU sheet, the surface temperature should be 260 °C to 288 °C (500 °F to 550 °F). Heaters should have a minimum watt density of 2 kW/ft² (21 kW/m²) of heating surface. A heater watt density of 4 kW/ft² to 5 kW/ft² (43 kW/m² to 54 kW/m²) is preferable. Heaters with a watt density of about 43 kW/m² (4 kW/ft²) set at 426 °C (800 °F) at a distance of 76 mm (3 inch) on both sides of 0.5 mm (20 mil) Udel® PSU sheet will heat the sheet in about 15 seconds. It is good practice to use some type of surface monitoring system to check sheet surface temperature, such as a hand-held IR pyrometer. Better still are machines equipped with sensors in the heater banks. Best results are obtained when the equipment has a zoned heating system that allows fine tuning of the surface temperature.

Single side heating can be used for sheet up to about 2.3 mm (90 mils) thick, but dual side heating is recommended. During heating, the sheet will appear to draw tight, and then start to buckle between the clamps as the strains are relieved. The sheet will then draw almost uniformly tight, and then start to sag. At this point, it is ready for molding. Heated sulfone sheet will sag relatively quickly, particularly in the heavier gauges where the weight is higher. It must be indexed rapidly over the mold, and sufficient clearance over the lower heaters must be provided.

Most of the conventional thermoforming methods such as vacuum forming, pressure forming, plug assist, and snap-back have been used successfully with sulfone based sheet. Parts with an area ratio as high as 9:1 have been formed commercially. Thermoformed prototypes can be produced with many types of molds such as wood, metal-filled epoxy, or cast aluminum. Hard wood molds only last for about 10 to 30 parts because of the high temperature conditions. Cast epoxy molds may last for 100 to 300 parts. Aluminum molds are capable of producing several thousand parts.

Production molds should be metal, and cored for heating with a fluid transfer medium at 149 °C (300 °F). Aluminum or steel molds are satisfactory, and reproduction of the mold surface is excellent. Mold shrinkage of unfilled sulfone resin is a uniform 0.7%. Ideally, the mold should operate at 149 °C to 166 °C (300 °F to 330 °F) to obtain minimum residual stress, and thus, maximum environmental stress cracking resistance in the part. Sulfone sheet sets rapidly. Parts can be demolded at 149 °C to 177 °C (300 °F to 350 °F).

The design of thermoforming molds for sulfone materials should follow these conventional guidelines for rigid, amorphous materials: round all corners as generously as part design permits, allow at least 3° draft on shallow parts, and at least 6° draft on deeply drawn parts, avoid undercuts, and drill vacuum holes with a maximum diameter of 0.4 mm (1/64 inch).

Due to the rapid set of the sheet, the vacuum system must be properly designed. Rapid application of vacuum is critical, therefore eliminate any 90° elbows in the vacuum piping. Use 45° elbows or flexible hoses to increase the rate of air removal.

A		N	
Acudel® Polyphenylsulfone Blends	5	Nozzles	16
B		P	
Back Pressure	18	Packing and Holding	17
Barrel Capacity	15	Part Ejection	14
Barrel Temperatures	17	Pin Gates	13
C		Piping and Tubing	23
Cavity Layout	12	Polymer Injection or Mold Filling	16
Clamp	15	Predrying	22
Controls	15	Press Maintenance	15
Cooling	17	Purging	24
D		R	
Diaphragm Gates	13	Radel® Polyphenylsulfone	5
Die Design	22	Regrind	19
Draft	14	Residence Time in the Barrel	18
E		Resin Drying	6
Edge Gates	13	Resin Flow Characteristics	9
Ejector Pins and/or Stripper Plates	14	Rheology	8
Extruded Product Types	23	Runner Systems	12
Extrusion	22	S	
Extrusion Temperatures	22	Screw Design	15
F		Screw Design Recommendations	22
Film	23	Screw Speed	18
G		Screw Tips and Check Valves	15
Gate Location	13	Sheet	23
Gating	12	Shrinkage	18
H		Shut-Down Procedure	24
Hot Runner Molds	11	Spiral Flow	9
I		Sprue Gating	12
Injection Molding	10	Start-Up Procedure	24
Injection Molding Equipment	15	Start-Up, Shut-Down, and Purging	24
Injection Rate	18	Sulfone Polymers	5
M		T	
Machine Settings	17	Thermoforming	25
Measuring Residual Stress	19	Three-Plate Molds	11
Melt Flow Index	9	Tool Steels	10
Mold Dimensions	10	Tool Wear	10
Molding Process	16	Tunnel or Submarine Gates	13
Mold Plating and Surface Treatments	10	Two-Plate Molds	11
Mold Polishing	10	U	
Molds and Mold Design	10	Udel® Polysulfone	5
Mold Temperature	18	V	
Mold Temperature Control	10	Venting	14
Mold Types	11	Veradel® Polyethersulfone	5
		Viscosity-Shear Rate	8
		W	
		Wire	23



Specialty Polymers

Worldwide Headquarters

SpecialtyPolymers.EMEA@solvay.com

Viale Lombardia, 20
20021 Bollate (MI), Italy

Americas Headquarters

SpecialtyPolymers.Americas@solvay.com

4500 McGinnis Ferry Road
Alpharetta, GA 30005, USA

Asia Headquarters

SpecialtyPolymers.Asia@solvay.com

No.3966 Jindu Road
Shanghai, China 201108

www.solvay.com

Safety Data Sheets (SDS) are available by emailing us or contacting your sales representative. Always consult the appropriate SDS before using any of our products.

Neither Solvay Specialty Polymers nor any of its affiliates makes any warranty, express or implied, including merchantability or fitness for use, or accepts any liability in connection with this product, related information or its use. Some applications of which Solvay's products may be proposed to be used are regulated or restricted by applicable laws and regulations or by national or international standards and in some cases by Solvay's recommendation, including applications of food/feed, water treatment, medical, pharmaceuticals, and personal care. Only products designated as part of the Solviva® family of biomaterials may be considered as candidates for use in implantable medical devices. The user alone must finally determine suitability of any information or products for any contemplated use in compliance with applicable law, the manner of use and whether any patents are infringed. The information and the products are for use by technically skilled persons at their own discretion and risk and does not relate to the use of this product in combination with any other substance or any other process. This is not a license under any patent or other proprietary right.

All trademarks and registered trademarks are property of the companies that comprise the Solvay Group or their respective owners.
© 2014, Solvay Specialty Polymers. All rights reserved. D 2006 | R 07/2015 | Version 5.0